

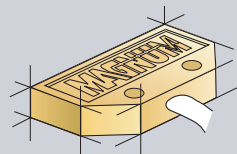

**Low Power Control Monitor for use in Explosionproof Hazardous Areas**

**Standard Sensor Options**

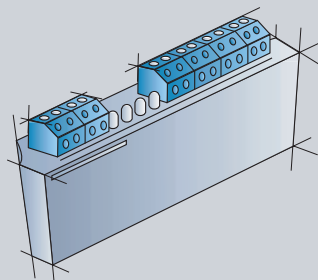
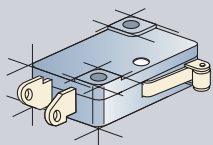

ATTENTION

Magnum and Proximity Sensors Only  
For low power ( $P \leq 240$  mW) and/or high DI card capacitance ( $C \geq 0.01$  mfd.) applications refer to the Reference Section Bulletin No. WD-13.02 or specify the MagPAC sensor module.

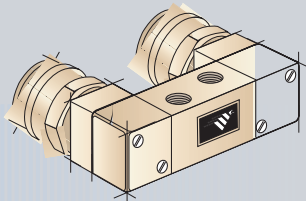

**Quantum™ Dual Coil Explosionproof**

Integrated within a high impact aluminum enclosure meeting NEMA 4, 4X, 7, 9, Class I, Groups C & D, Class II, Groups E, F, & G, Division 1 and 2 explosionproof requirements and certified to Factory Mutual and Canadian Standards, the Quantum™ standardly houses two high current mechanical or Magnum™ proximity sensors and a wide range of integrated dual coil

Falcon™ solenoid valves in four-way configurations. Falcon solenoid valves are available in a variety of coil voltages and body materials with stainless steel internals as standard. Cv. values range from .5 to 1.2.

**Micro-Switch V3**

SPDT Form C, UL, CSA

SPDT (V3)			DPDT (Licon)		
AMPS	VAC	VDC	AMPS	VAC	VDC
15	125		10	125	
15	250		10	250	
6		24	10		28
.5		125			
.25		250			

**MagPac™ Modular Sensors**

Bifurcated Reed Proximity Sensor, SPST • FM, CSA (Hermetically Sealed)

mA	VAC	VDC
2-750	120	120
2-750		24

**MAGNUM™ Proximity Sensors**

High Current Proximity Sensor, SPST/SPDT Form C • UL, CSA (Hermetically Sealed)

Rhodium			Tungsten (SPDT Only)		
Amps	VAC	VDC	Amps	VAC	VDC
0.295	120		3	120	
0.15	240		1.5	240	
1		24	2		24

**COIL POWER SUPPLY**

	COILS			
Operating Voltage	24 VDC	120 VAC	125 VDC	220 VAC
Wattage	0.55 Watts	4 Watts	1 Watts	4 Watts
Operating Current	22 mA	27 mA	8.60 mA	17.5 mA
Coil Resistance	1050 Ohms	1100 Ohms	14500 Ohms	3750 Ohms

# Quantum™ Dual Coil Explosionproof

AREA CLASSIFICATIONS	
NEMA 4, 4x, 7, 9	
Class I, Groups C, D	
Class II, Groups E, F, G, Div. 1 & 2	

## ORDERING GUIDE (FALCON™ SOLENOID)

COILS	CV	Body	4-Way
<b>XSO</b> 24 VDC 0.55 watts	.5Cv	Brass	2000
		Alum.	3000
		303 S.S.	4000
<b>XAO</b> 120 VAC 4.0 watts	1.2 Cv	316 S.S.	5000
		Brass	2Y00
		Alum.	3Y00
<b>XVO</b> 125 VDC 1.0 watts	1.2 Cv	303 S.S.	4Y00
		316 S.S.	5Y00
		Alum.	3Z00
<b>XHO</b> 220 VAC 4.0 watts	3.5 Cv	Alum.	3Z00
		303 S.S.	4Z00

**OPTIONAL FEATURES** (See BULLETIN NO. Q-18.02)

### DIMENSIONS (inches/mm)



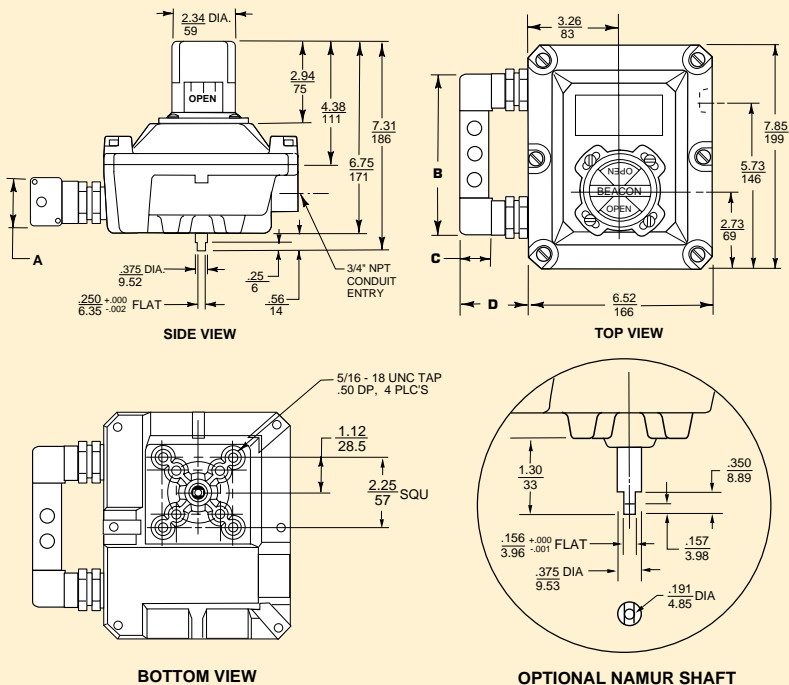





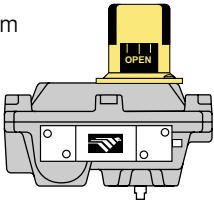

**Model 877**

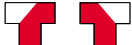

Solenoid Valve	Dimensions			
	A	B	C	D
.3 & .5 Cv	1.50	5.13	1.13	3.15
1.2 Cv	2.00	6.69	1.38	3.41

Note: Operating pressure: 45-120 psi.

### ORDERING GUIDE

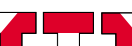
QUANTUM™ LP	BEACON™	3-WAY BEACON™	SENSOR	SOLENOID (Falcon™)
<b>877</b> Aluminum   NEMA 4, 4x, 7, 9 Class I, Groups C, D Class II, Groups E, F, G, Division 1 & 2  	<b>STANDARD</b> (Black & Yellow) <b>BY</b> 	<b>90° Rotation B1</b> 	Mech. (SPDT) <b>2M2</b> Mech. (DPDT) <b>2M4</b> Magnum (SPDT) <b>2M6</b> MagPAC 2 (SPST) Module w/ LED indication <b>M13</b>	Use above listing for ordering sole- noid  
	<b>ANSI GREEN</b> (Liquid-Low Hazard) <b>AG</b> 	<b>90° Rotation B3</b> 	<b>TRANSMITTERS</b>  1000 ohms <b>RS</b> 4-20 mA <b>CS</b>	
	<b>ANSI BLUE</b> (Gas-Low Hazard) <b>AB</b> 	<b>90° Rotation B5</b> 		
	<b>ANSI RED</b> (Fire Quenching) <b>AR</b> 	<b>180° Rotation B7</b> 		
		<b>180° Rotation B9</b> 		

Ordering Example: Quantum LP Explosionproof, aluminum enclosure with standard black & yellow Beacon, 2 Magnum Sensors and Falcon 120 VAC/4.0 watts, .5 Cv, brass, 4-Way solenoid valve. 877-BY-2M6-XAO2000